



ChargePoint® Home Flex

16A-50A Flexible Amperage Charger

Installation Guide for J1772 and NACS



ATTENTION: Installers, please read this guide thoroughly. Do not throw this guide away. Return the guide to the owner after installation.

Important Safety Instructions

SAVE THESE INSTRUCTIONS



WARNING: This manual contains important instructions for Home Flex. When using electric products, always follow basic precautions, including the following.

- 1. Read and follow all warnings and instructions before installing and operating the ChargePoint® charging station.** Install and operate only as instructed. Failure to do so may lead to death, injury, or property damage, and will void the Limited Warranty.
- 2. Only use licensed professionals to install your ChargePoint charging station and adhere to all national and local building codes and standards.** Before installing the ChargePoint charging station, consult with a licensed contractor, such as a licensed electrician, and use a trained installation expert to ensure compliance with local building and electrical codes and standards, climate conditions, safety standards, and all applicable codes and ordinances. Inspect the charging station for proper installation before use.
- 3. Always ground the ChargePoint charging station.** Failure to ground the charging station can lead to risk of electrocution or fire. The charging station must be connected to a grounded, metal, permanent wiring system, or an equipment grounding conductor shall be run with circuit conductors and connected to the equipment grounding terminal or lead on the Electric Vehicle Supply Equipment (EVSE). Connections to the EVSE shall comply with all applicable codes and ordinances.
- 4. Install the ChargePoint charging station using a ChargePoint approved method.** Failure to install on a surface that can support the full weight of the charging station can result in death, personal injury, or property damage. Inspect the charging station for proper installation before use.
- 5. This charging station is not suitable for use in Class 1 hazardous locations, such as near flammable, explosive, or combustible vapors or gases.**
- 6. This device should be supervised when used around children.**
- 7. Do not put fingers into the electric vehicle connector.**
- 8. Do not use this product if any cable is frayed, has broken insulation, or shows any other signs of damage.** Call ChargePoint Support immediately at 1.888.758.4389 (24 hours).
- 9. Do not use this product if the enclosure or the EV connector is broken, cracked, open, or shows any other signs of damage.** Call ChargePoint Support immediately at 1.888.758.4389 (24 hours).

-
10. Use 90°C wire copper conductors only.
 11. Do not operate the charging station in temperatures outside its operating range.
For charging stations set to 16-48 A, the range is -40°F to 122°F (-40°C to 50°C).
For charging stations set to 50 A, the range is -40°F to 113°F (-40°C to 45°C).
- Other than the charging cable, Home Flex contains no field serviceable parts. Do not attempt to repair or service any other part of the unit yourself. If the unit requires servicing, contact ChargePoint, Inc.
 - Ensure the Home Flex charging cable is positioned so it is not stepped on, tripped over, or subjected to damage or stress. Do not close a garage door on the charging cable.



IMPORTANT: Under no circumstances will compliance with the information in a ChargePoint guide such as this one relieve the user of the responsibility to comply with all applicable codes and safety standards. This document describes approved procedures. If it is not possible to perform the procedures as indicated, contact ChargePoint. **ChargePoint is not responsible for any damages that may result from custom installations or procedures not described in this document or that fail to adhere to ChargePoint recommendations.**

Product Disposal

ChargePoint Home Flex is electronic and therefore may not be disposed of as part of unsorted domestic waste. Inquire with local authorities regarding proper disposal. Product materials are recyclable as marked.



Document Accuracy

The specifications and other information in this document were verified to be accurate and complete at the time of its publication. However, due to ongoing product improvement, this information is subject to change at any time without prior notice. For the latest information, see our documentation online at chargepoint.com/guides.

Copyright and Trademarks

©2013-2023 ChargePoint, Inc. All rights reserved. This material is protected by the copyright laws of the United States and other countries. It may not be modified, reproduced, or distributed without the prior, express written consent of ChargePoint, Inc. ChargePoint and the ChargePoint logo are trademarks of ChargePoint, Inc., registered in the United States and other countries, and cannot be used without the prior written consent of ChargePoint.



CAN ICES-3 (A)/NMB-3 (A)



Table of Contents

Important Safety Instructions	2
Verify Contents	6
Gather Tools	8
Plan the Location	9
Wire the Circuit	11
Mount the Charging Station	12
Install the Charging Cable	18
Complete the Installation	20
Access the Installer App	21
Questions?	24
Limited Warranty	25

Verify Contents



CAUTION: The ChargePoint Home Flex charging station must be installed by a licensed electrician. If you do not know where to find one, refer to the ChargePoint Home Flex Quick Start Guide or [chargepoint.com/homeinstall](https://www.chargepoint.com/homeinstall) for help.

Check the box (J1772 Home Flex factory configuration order) to ensure you have the Quick Start Guide, this Installation Guide, and these parts:

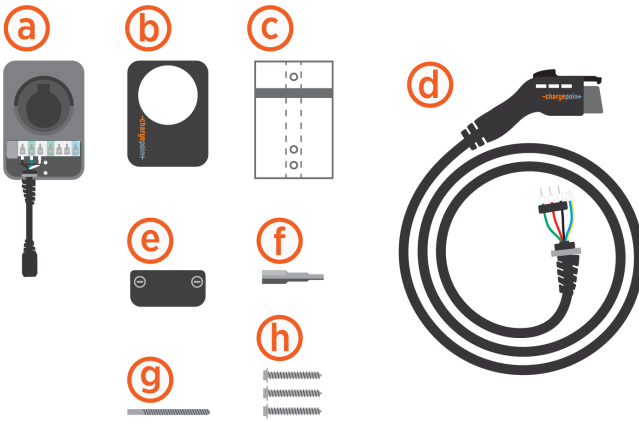

- (a) Charging station (if applicable, with attached input power cable)
- (b) Faceplate (pre-installed on charging station)
- (c) Installation template
- (d) Charging cable connector (J1772) with cable clip
- (e) Wire cover (pre-installed on charging station)
- (f) 10 mm (3/8 in) driver bit
- (g) 4 mm (3/16 in) drill bit
- (h) Three 6 mm (1/4 in) x 51 mm (2 in) lag screws

Check the box (NACS Home Flex factory configuration order) to ensure you have the Quick Reference Guide, and these parts:

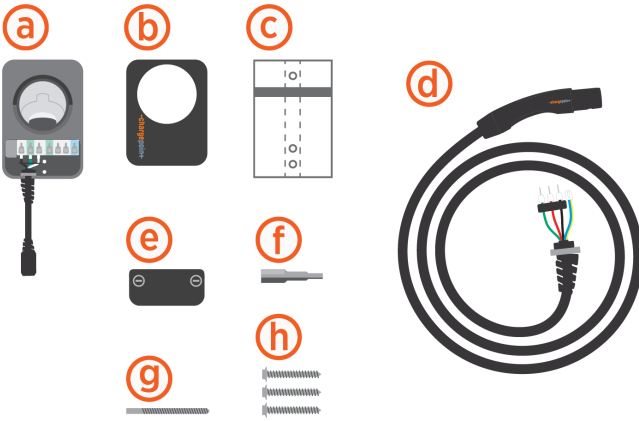

- (a) Charging station with NACS holster ball insert (if applicable, with attached input power cable)
- (b) Faceplate (pre-installed on charging station)
- (c) Installation template
- (d) Charging cable connector (NACS) with cable clip
- (e) Wire cover (pre-installed on charging station)
- (f) 10 mm (3/8 in) driver bit
- (g) 4 mm (3/16 in) drill bit
- (h) Three 6 mm (1/4 in) x 51 mm (2 in) lag screws

Note: If you are missing any of these parts, call 1.888.758.4389 (24 hours).

Note: Visit chargepoint.com/guides and find the "ChargePoint Home Flex" section for full instructions for NACS cable installation.

Gather Tools

You also need:

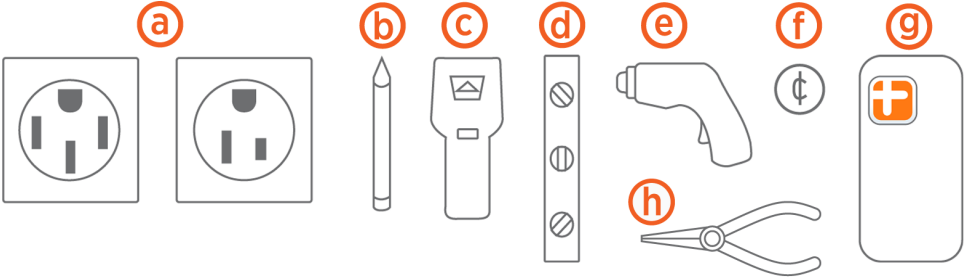

- (a) One NEMA 14-50 outlet, or one NEMA 6-50 outlet, or supplies to install a hardwired circuit
- (b) Pencil
- (c) Stud finder
- (d) Level
- (e) Drill
- (f) Coin
- (g) ChargePoint Installer app on your smartphone
Scan the QR code to download the app, and sign up if necessary.



- (h) Needle-nose pliers

Plan the Location



IMPORTANT: While this charger can be installed as either a plug-in or hardwired, we recommend hardwiring for optimal performance.

Before beginning work, check the site for appropriate mounting location and electrical capacity.

1. Ensure the homeowner has chosen an installation location that allows the charging cable to reach the car's charging port while still providing slack. Mount the charging station on a surface that can support the full weight of the charging station with the cord hanging from it. Follow the steps below to mount on a surface using the supplied screws. Ensure Wi-Fi signal is available.

Note: Outdoor installation requires hardwiring or an outdoor-rated, weather-resistant electrical outlet.

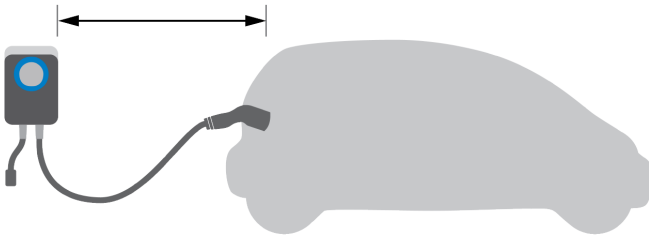

WARNING: In areas with frequent thunderstorms, add surge protection at the service panel. Ensure all power and ground connections, especially those at the breaker and bus bar, are clean and tight. Remove all oxide from all conductors and terminals before connecting wiring.

2. Home Flex must be set to match the rating of the circuit as determined by the available panel capacity.
-



CAUTION: Home Flex is a continuous load device. The circuit must be rated for 125% of the maximum load.

Consult all applicable codes for breaker and wire sizing requirements. The field-wiring terminal is rated to 105 °C (221 °F) and accepts a maximum of 16 mm² (6 AWG) wire. Home Flex supports the following amperages for circuit capacity:

Table: Home Flex supports the following amperages for circuit capacity

Circuit Rating	Max Load	Estimated Range per Hour	Plug-in	Hardwire
80 A	50 A	37 miles/60 km	no	yes
70 A	50 A	37 miles/60 km	no	yes
60 A	48 A	36 miles/58 km	no	yes
50 A	40 A	30 miles/48 km	yes	yes
40 A	32 A	25 miles/40 km	yes	yes
30 A	24 A	18 miles/29 km	no	yes
20 A	16 A	12 miles/19 km	no	yes



IMPORTANT: In Canada, a plug-in installation is only allowed with a 50 A circuit.

- For plug-in installation, determine the plug type purchased by the homeowner. It is either a NEMA 14-50 or 6-50 type plug.



14-50



6-50

- For a hardwired installation, determine if the desired circuit rating requires a hardwired circuit.

5. Ensure the electrical panel supports a 240 V dedicated circuit with a new, dedicated, non-GFCI two-pole circuit breaker, in accordance with local codes and ordinances.

Note: If local codes require a GFCI breaker for plug-in installation, ChargePoint recommends a hardwire installation. We do not recommend using a GFCI breaker as the Home Flex has charging circuit interrupting device (CCID) protection. Using a GFCI breaker in the panel can cause nuisance tripping.

6. For plug-in installations, the outlet should be located 0.45-0.66 m (20-26 in) from the ground adjacent to the stud where the charging station will be mounted.

Note: The input power cable is 0.45 m (18 in) long (as per the National Electric Code for EV chargers). Ensure the outlet is installed close enough to the stud for the input power cable to plug in.

7. Follow all applicable codes and ordinances and pull a permit for completing the electrical work as required.

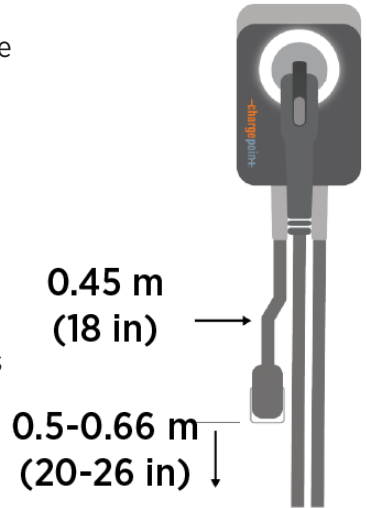

Wire the Circuit

1. Turn off the circuit breaker to the 240 V outlet.



WARNING: RISK OF SHOCK. Do not restore power to the outlet until installation is complete. Failure to follow these instructions could result in shock or electrocution.

2. Install a circuit:
 - For a 40 or 50 A plug-in installation, wire the circuit with the appropriate 6-50 or 14-50 outlet. Install the outlet with the ground facing up.
 - For a hardwired installation, provide a listed conduit with wiring to the bottom or rear 19 mm (3/4 in) knockout for AC input. Seal the unused knockout with the plug provided.
3. Affix the label with the appropriate rating to the circuit in the panel.
4. Ensure power is off to the circuit at the panel before proceeding.

Mount the Charging Station

Note: For hardwired installation, see the [Hardwired Installation](#) section below.

Plug-In Installation

1. Remove the faceplate and the wire cover from the charging station and set them aside.
2. Mark the center of the mounting location with a vertical line at a height between 1-1.1 m (39-43 in) above the floor. This must be centered on a stud or other structurally suitable surface.

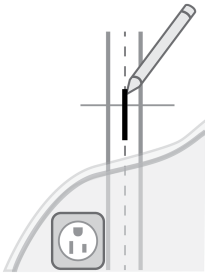

3. To find the charging station's ideal mounting height, plug the charging station's input power cable into the outlet.

DANGER: If the front status light turns on when the charging station is plugged in, the circuit is not off.



STOP IMMEDIATELY. Unplug the charging station and turn off the power to the outlet at the circuit breaker until the installation is complete.

4. Hold the station against the wall, centered on the mark you just made.

Note: Ensure the input power cable has a slight curve, and is not stretched.

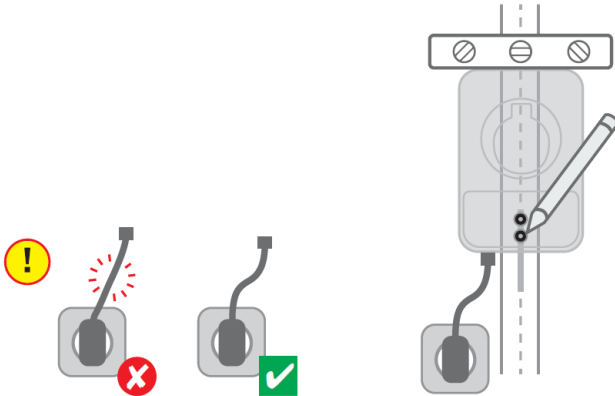

5. Mark the two lower mounting holes through the holes in the station, then unplug the charging station and set aside.
6. Place the template on the wall, aligning the lower template holes with the two marks you made.
7. Mark the top mounting hole on the wall using the top hole in the template. All three marks should be on the vertical line you first made.

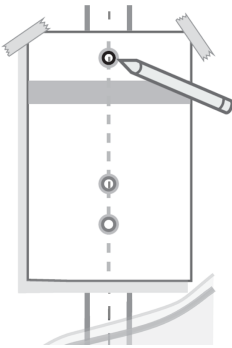

8. Remove the template from the wall.
9. Drill the three mounting holes on the marks using the included drill bit.
10. Use the driver bit to drive a screw into the top-most mounting hole, leaving a 3 mm (1/8 in) gap to hang the charging station on.

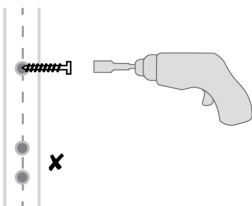

11. Hang the charging station on the screw using the top notch on the back.

Note: Do not plug the charging station in yet.

12. Drive the remaining two lag screws into the bottom mounting holes to secure the charging station.

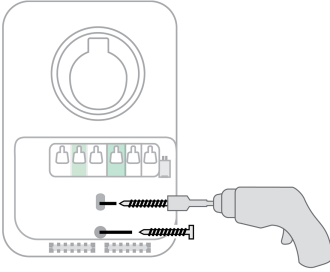

Note: Ensure the screw does not make contact with the input wire.

For more information, see the [Install the Charging Cable](#) section below.

Hardwired Installation

Note: The conduit can be connected to the station at the bottom or the rear knockouts.

1. Remove the faceplate and the wire cover from the charging station and set them aside.

Note: To hardwire a ChargePoint Home Flex with a pre-installed NEMA power cord, remove the plug by lifting the three white levers on the left of the terminal block, and lifting and pulling out the cable clip. Using a pair of needle-nose pliers can make removing the clip easier.

2. Mark the center of the mounting location with a vertical line at a height between 1.0-1.1 m (39-43 in) above the floor. This must be centered on a stud or other structurally suitable surface.

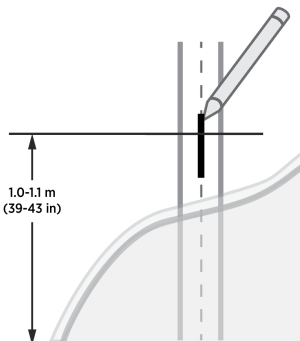

3. Hold the station against the wall, centered on the mark you just made. The top of the station should be approximately 1.3 m (50 in) above ground level.

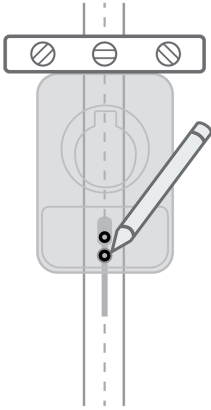

4. Mark the two lower mounting holes through the holes in the station, then set aside.
5. Place the template on the wall, aligning the lower template holes with the two marks you made.
6. Mark the top mounting hole on the wall using the top hole in the template. All three marks should be on the vertical line you first made.

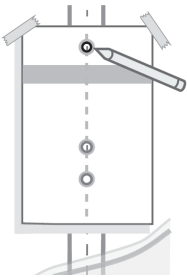

7. Remove the template from the wall.
8. Drill the three mounting holes on the marks using the included drill bit.

- Use the driver bit to drive a lag screw into the top-most mounting hole, leaving a 3 mm (1/8 in) gap to hang the charging station on. Keep the remaining two screws for later use.

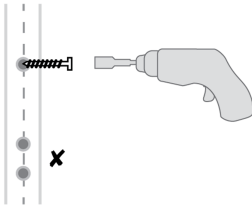

- If bringing power through the back of the station, remove the rear knockout plug and route the wires through before hanging the station.

Note: If mounting on an exterior wall and bringing power through the rear knockout, apply sealant around the rear knockout to prevent water ingress.

- Hang the charging station on the screw using the top notch on the back.

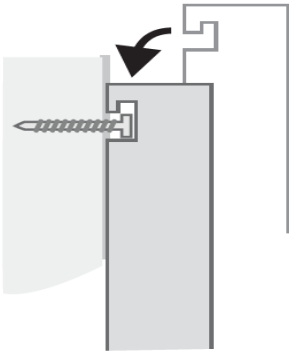

- Drive the remaining two lag screws into the bottom mounting holes to secure the charging station.

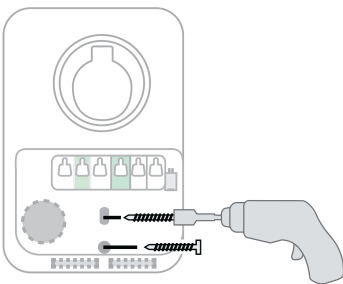

- Ensure the service wiring can easily reach the connectors on the charging station's input terminal block.

-
14. Tighten the locknut on the conduit fitting.
 15. Strip each wire 12 mm (1/2 in).
 16. Lift the white levers to open the terminal block. Fully insert the wires into the connectors on the left side of the terminal block with the ground wire in the center. Ensure to insert the wires in the correct order, where left terminal corresponds to Line 1 (L1), middle terminal is Ground (GND), and right terminal is Line 2 (L2).

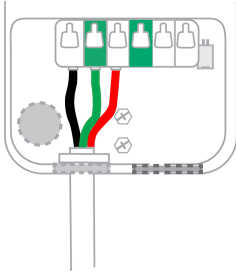

17. Press the levers down until they snap into place to secure the wires in the terminal block. Pull on the wires to ensure they are properly secured.

Note: The levers snap shut with great force. Keep fingers away from underneath the levers.

Install the Charging Cable

1. Turn off the circuit breaker to the 240 V outlet.



WARNING: RISK OF SHOCK. Do not restore power to the outlet until installation is complete. Failure to follow these instructions could result in shock or electrocution.

2. Remove the cable clip from the wire end of the cable, but do not discard it.

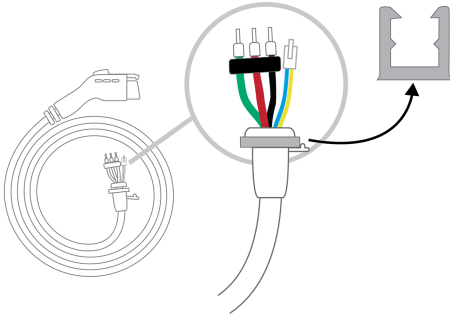

3. Lift the white levers to open the terminal block.
4. Insert the wires of the charging cable through the bottom hole of the charging station.
5. Match the green wire to the ground terminal on the left side of the output block.
6. Insert the ends of the wires into the corresponding holes, pushing the cables up until the silver conductors are no longer visible.
7. Press the three levers down until they snap into place.

Note: The levers snap shut with great force. Keep fingers from underneath the levers.

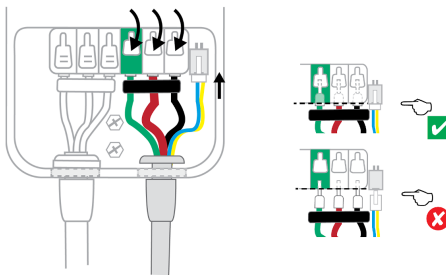

8. Insert the white plug into the connector towards the right of the terminal block.
9. Push up on the charge cable strain relief and slide the cable clip into the slot. This secures the cable in place.

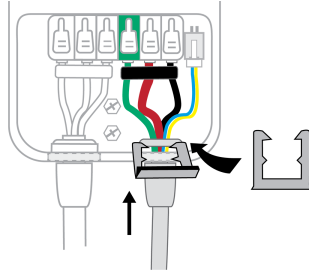

10. Install the wire cover using a coin to lock it in place.

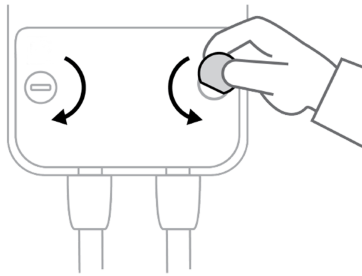

11. Locate the rating label on the bottom of the station. Apply the new rating label that matches the station's circuit.

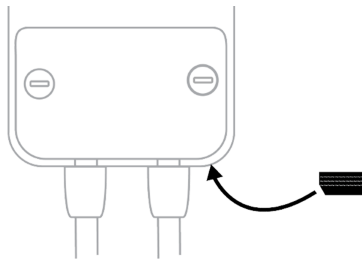

12. Snap the faceplate onto the charging station.

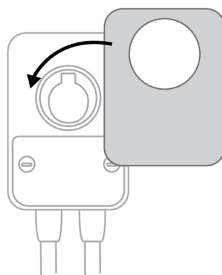

Complete the Installation

1. Extend the cable to its full length to remove any twists or tension.
2. Drape the charging cable over the top of the charging station and dock the connector in its holster.
3. Ensure labels specifying circuit amperage are applied to the bottom of the charging station and to the circuit in the electrical panel.
4. Plug the charging station into the outlet (if applicable).

Note: The images below represent a ChargePoint charging station integrated with two different adapters:

(a) J1772 cable

(b) NACS cable

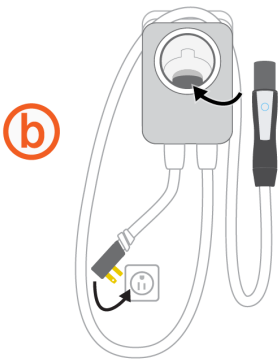
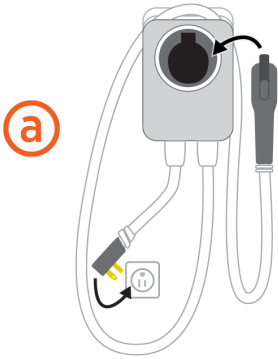

5. Restore power to the circuit at the electrical panel.
6. Watch to ensure the front status light glows yellow, then blinks white.

Note: For more information, see the [Charger Status Lights](#) section below.

-
7. Return all packaging materials to the box and give the box to the homeowner.

Note: Do not throw the guide away. Give the Quick Start Guide, the drill bit, the driver bit, and this Installation Guide to the homeowner.

Access the Installer App

1. Scan the QR code to download the app, and sign up if necessary.



2. Open the ChargePoint Installer app and log in.
3. Do the following in the app:

- a. Select **Get Started** and follow the app instructions.
- b. Select the installation type.
- c. Set the appropriate breaker settings.

Note: See [Plan the Location](#) section to determine the desired breaker rating (i.e., charging amperage).

- d. Send a notification to the homeowner via Mobile or Email.

The homeowner will receive a notification that the installation is complete and to activate the charging station.

Note: If you are unable to set the breaker rating via the ChargePoint Installer app, set the breaker rating via the homeowner's ChargePoint account using the ChargePoint app. To do so, see the steps below.

4. **Activate the station to enable advanced features. The homeowner must follow these steps:**

- a. Refer to the Quick Start Guide.

Note: The Quick Start Guide contains information that the homeowner needs to complete the charging station setup and activate it.

- b. Complete the charging station setup by downloading the ChargePoint app (distinct from the ChargePoint Installer app).

On the ChargePoint app, select **Home Charger** and choose **Set Up**. Depending on the app version, the **Home Charger** option may appear either under **(a)** menu icon or **(b)** home icon.



Note: The electrician sets the maximum current by using the ChargePoint Installer app, but the homeowner must activate the station and complete the setup using the ChargePoint driver app.

Charging Station Status

Table: Charging Station Status









Light	What it Means
	Updating software or booting
	The charger needs to be set up in the app
	Ready to charge
	The charger is on a schedule. Plug in twice to charge immediately.
	Plugged in
	Currently charging

Table: Charging Station Status (continued)

Light	What it Means
	<p>Not connected to Wi-Fi Check Wi-Fi in app</p>
	<p>Something's wrong If the station is displaying an error, refer to our Troubleshooting Guide or scan the QR code for quick access to the guide.</p> 
	<p>Wi-Fi and fault indicators</p> <ul style="list-style-type: none"> ◦ Green light on-connected to Wi-Fi ◦ Green light off-not connected to Wi-Fi ◦ Red light off-no fault detected ◦ Red light on-fault detected

Questions?

Contact ChargePoint Support at 1.888.758.4389 or chargepoint.com/support.

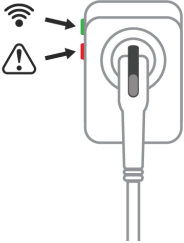
Limited Warranty

Limited Warranty for ChargePoint Home Electric Vehicle charging station

Our Promise

This Limited Warranty for ChargePoint Home Electric Vehicle charging station (“Warranty”) applies to you, the original purchaser of a new CHARGEPOINT HOME charging station (the “charging station”) from ChargePoint solely for use by you at your residence. This warranty is not transferable and is valid for purchasers located in the U.S.A. and Canada only.

LIMITED THREE-YEAR PARTS EXCHANGE WARRANTY: Subject to the exclusions from Warranty coverage set forth below, ChargePoint warrants that, when used under normal operating conditions, your charging station will be free from any defects in materials or workmanship for a period (the “Warranty Period”) of three (3) years from the date of original purchase. If, during the Warranty Period, your charging station becomes defective in breach of the Warranty, ChargePoint will, upon written notice of the defect received during the Warranty Period, either repair or replace, at ChargePoint’s election, the charging station. The Warranty covers both parts and factory labor necessary to repair your charging station, but does not include any on-site labor costs related to un-installing or reinstalling the repaired or replacement charging station.

Follow These Easy Steps to Obtain Warranty Service

1. If at any time during the term of your Warranty you believe you have a defective charging station, contact Customer Service at 1.888.758.4389 or chargepoint.com/support and request a Return Material Authorization (“RMA”) number from ChargePoint.
2. In connection with your RMA request, you will be asked for each of the following:
 - A detailed description of the problems you are experiencing with the charging station;
 - The model number and serial number of the charging station;
 - Proof of purchase; and
 - Shipping information.
3. If ChargePoint determines that the defect appears to be covered by your Warranty and your Warranty is still in effect you will be provided a Returned Material Authorization number (RMA number) to reference when returning the defective charging station for repair or replacement.
4. Ship the defective charging station to ChargePoint and reference the RMA number in the shipping documentation. The charging station must be returned in its original shipping container or in another shipping container designed to prevent damage to the charging station.

-
5. If your charging station is covered by your Warranty, ChargePoint will either repair or replace the defective charging station at no charge to you and ship the repaired or replaced charging station back to you at ChargePoint's expense.

Important

1. You are responsible for the proper installation and maintenance of the charging station including the un-installing of any defective charging station and the installation of the repaired or replacement charging station returned to you.
2. Any service or repairs beyond the scope of the Warranty above will be performed upon customer approval at ChargePoint's then prevailing labor rates and other applicable charges.
3. Any charging station that is found by ChargePoint to be out-of-warranty or otherwise ineligible for warranty service will be returned, repaired or replaced upon your approval at ChargePoint's standard charges at your expense.
4. Please read carefully through the detailed descriptions of the WARRANTY, the EXCLUSIONS FROM LIMITED PRODUCT WARRANTY, and the LIMITATIONS ON WARRANTY AND LIABILITY on the following pages to assure that your charging station is eligible for warranty service without additional cost to you.

Replacement Parts Or Charging Stations

You acknowledge that replacement parts or charging stations provided by ChargePoint under the Warranty may be remanufactured or reconditioned parts or charging stations or, if the exact charging station is no longer manufactured by ChargePoint, a charging station with substantially similar functionality ("Replacement Products"). All replaced parts, whether under warranty or not, become the property of ChargePoint.

Any replacement parts or charging station so furnished will be warranted for the remainder of the original Warranty Period, or ninety days from the date of delivery of such replacement parts or charging station, whichever is later. Should ChargePoint be unable to repair or replace your charging station, ChargePoint will refund the purchase price of the charging station to you.

Exclusions from Limited Product Warranty



IMPORTANT: The Warranty on your charging stations shall not apply to defects or service repairs resulting from the following:

- Improper site preparation or maintenance, improper installation, cosmetic damage such as scratches and dents, or normal aging.

-
- Abuse, vandalism, damage or other problems caused by accidents, misuse or negligence (including but not limited to physical damage from being struck by a vehicle), or use of the charging station in a way other than as specified in the applicable ChargePoint documentation.
 - Damage to the charging station caused by software, interfacing, parts, supplies or any other product not supplied by ChargePoint.
 - Installation, alteration, disassembly, modification, or relocation of the charging station that was not approved in writing or by ChargePoint or performed by ChargePoint or by a licensed electrician pursuant to this guide.
 - Damage as a result of extreme power surge, extreme electromagnetic field or any acts of nature. Any other causes beyond the control of ChargePoint.
 - Use of the charging station in conjunction with any non-genuine ChargePoint accessory or part (e.g., third party cable/plug).

IN ADDITION: The Warranty on your charging station shall not apply if the original identification markings (for example, serial numbers and trademarks) have been defaced, altered or removed or if the charging station is used or installed for any purpose other than for use at a single family residence.

CHARGEPOINT SPECIFICALLY DOES NOT WARRANT THAT ANY CHARGEPOINT SERVICES WILL BE ERROR FREE OR WILL OPERATE WITHOUT INTERRUPTION.

Limitations on Warranty and Liability

NO AGENT OF CHARGEPOINT IS AUTHORIZED TO ALTER OR EXCEED THE WARRANTY OBLIGATIONS OF CHARGEPOINT. THE REMEDIES IN THIS LIMITED PRODUCT WARRANTY ARE YOUR SOLE AND EXCLUSIVE REMEDIES. CHARGEPOINT MAKES NO OTHER EXPRESS OR IMPLIED WARRANTIES OTHER THAN THE WARRANTY SET FORTH ABOVE. ALL OTHER WARRANTIES, INCLUDING WITHOUT LIMITATION ANY WARRANTY OF DESIGN, MERCHANTABILITY, FITNESS FOR A PARTICULAR PURPOSE (EVEN IF CHARGEPOINT HAS BEEN INFORMED OF SUCH PURPOSE) OR AGAINST INFRINGEMENT, ARE EXCLUDED TO THE EXTENT PERMITTED BY LAW. IF ANY IMPLIED WARRANTY CANNOT BE DISCLAIMED UNDER APPLICABLE LAW, SUCH IMPLIED WARRANTY SHALL BE LIMITED IN DURATION TO THE WARRANTY PERIOD DESCRIBED ABOVE. NO WARRANTIES APPLY AFTER EXPIRATION OF THE WARRANTY PERIOD.

Some states or jurisdictions do not allow the exclusion of express or implied warranties or limitations on how long an implied warranty lasts, so the above limitation may not apply to you.

CHARGEPOINT IS NOT LIABLE FOR ANY DIRECT, INDIRECT, INCIDENTAL, SPECIAL, PUNITIVE OR CONSEQUENTIAL DAMAGES, INCLUDING WITHOUT LIMITATION LOST PROFITS, LOST BUSINESS, LOST DATA, LOSS OF USE, OR COST OF COVER INCURRED BY YOU ARISING OUT OF OR RELATED TO YOUR PURCHASE OR USE OF, OR INABILITY TO USE, THE CHARGING STATION, UNDER ANY THEORY OF LIABILITY, WHETHER IN AN ACTION IN

CONTRACT, STRICT LIABILITY, TORT (INCLUDING NEGLIGENCE) OR OTHER LEGAL OR EQUITABLE THEORY, EVEN IF CHARGEPOINT KNEW OR SHOULD HAVE KNOWN OF THE POSSIBILITY OF SUCH DAMAGES. IN ANY EVENT, THE CUMULATIVE LIABILITY OF CHARGEPOINT FOR ALL CLAIMS WHATSOEVER RELATED TO THE CHARGING STATION WILL NOT EXCEED THE PRICE YOU PAID FOR THE CHARGING STATION. THE LIMITATIONS SET FORTH HEREIN ARE INTENDED TO LIMIT THE LIABILITY OF CHARGEPOINT AND SHALL APPLY NOTWITHSTANDING ANY FAILURE OF ESSENTIAL PURPOSE OF ANY LIMITED REMEDY.

Some states or jurisdictions do not allow the exclusion or limitation of incidental or consequential damages, so the above limitation or exclusion may not apply to you.

Additional Information

This Warranty shall be governed by and construed in accordance with the laws of the State of California, U.S.A., exclusive of its conflict of laws principles. The U.N. Convention on Contracts for the International Sale of Goods shall not apply.

This Warranty is the entire and exclusive agreement between you and ChargePoint with respect to its subject matter, and any modification or waiver of any provision of this statement is not effective unless expressly set forth in writing by an authorized representative of ChargePoint.



chargepoint.com/support

75-001336-01 r10